

Sub-System Description Sheet

Sub-System Specification

System Parameters	Specifications	Note
Target Voltage	25 to 100 kV	Contact Trufocus for applications requires < 25kV
Tube Current	0.02 to 1 mA	
Focal Spot Size	<= 8 um	
Tube Power	8* W	
Tube type	End Window Flat (EWF)	

*Maximum Tube Power depends on Focus Spot Size and target material. 8 W for 8 um

Parts needed to build the Sub-system

Modules	TruFocus Ordered P/N	QTY
MicroFocus X-ray Source	TFX-8100-EWF	1
MicroFocus Digital Controller	MFX-CTR-100-1-D	1
High Voltage Module	MFX-PS-100-1-A	1
PC Software Driver	Included	

Enclosed please find all Data Sheets of each parts described above.

TFX-8100-EWF

MicroFocus X-Ray Source

(End Window Flat)

Contact TruFocus for any modification of Specifications for your application

MFX FAMILY	TruFocus Ordered P/N	Maximum Target Voltage (kV)	Maximum Target Current (mA)	Maximum TUBE Power (W)	Focal Spot Size (um)	Beam Angle	Operation
TFX	TFX-8100-EWF	100	1	8*	<= 8	57° +- 0.5°	Continuous

*Maximum Tube Power depends on Focal Spot Size (FSS) and target material. See Tube Operating Power table below. 8 W for 8 um.

TFX-8100-EWF X-Ray source is part of the TruFocus 8000 series MicroFocus Tube family developed to fulfill the need for high resolution imaging for Industrial, Medical, Aerospace and Analytical applications. The <=8 μm Focal Spot Size produces exceptional image quality and sharpness.

To shorten X-ray system development time, a well matched High Voltage (100kV, 1 mA) power supply , an Analog or Digital (USB) Controller and Software Driver with full control graphic interface developed by TruFocus are available for driving and monitoring the TFX-8100-EWF source.

Operating Power (Continuous)

Maximum Tube Operating Power (W) of 8000 series is: 12 W

1W per 1 um Focal Spot Size (FSS) for Tungsten when FSS < 10 μm

Focal Spot Size (um)	Maximum Target Operating Power (Continuous) (W)
8	8
9	9
10	10 - 12

X-Ray Tube Specification

Tube Housing	Target Material	Window Material	Window Thickness	Window type	Operating Temp. & Humidity	Storage Temp. & Humidity	Cooling Method	Weights	Flux Stability
Encapsulated	Tungsten	Beryllium	0.01 “	End Window Flat	+10° to 55°C / 85% RH	0° to 60°C 85% RH	Air	2.5 lbs	<0.2%*

*Relative Standard Deviation over 4 hours of continued operation.

TFX-8100-EWF



TFX-8100-EWF (With Housing)

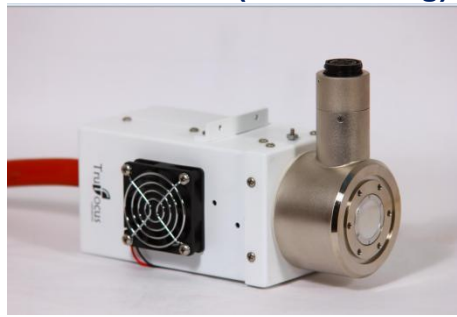

Packaged in a metal housing with FAN

OUTLINE DRAWING

Drawing# & Version:	DW-TFX-8100-EWF-01
TruFocus P/N:	TFX-8100-EWF
Unit:	In

- High Voltage Cable length can be modified based on Customer requirement and needs to be defined at the time of purchase order.

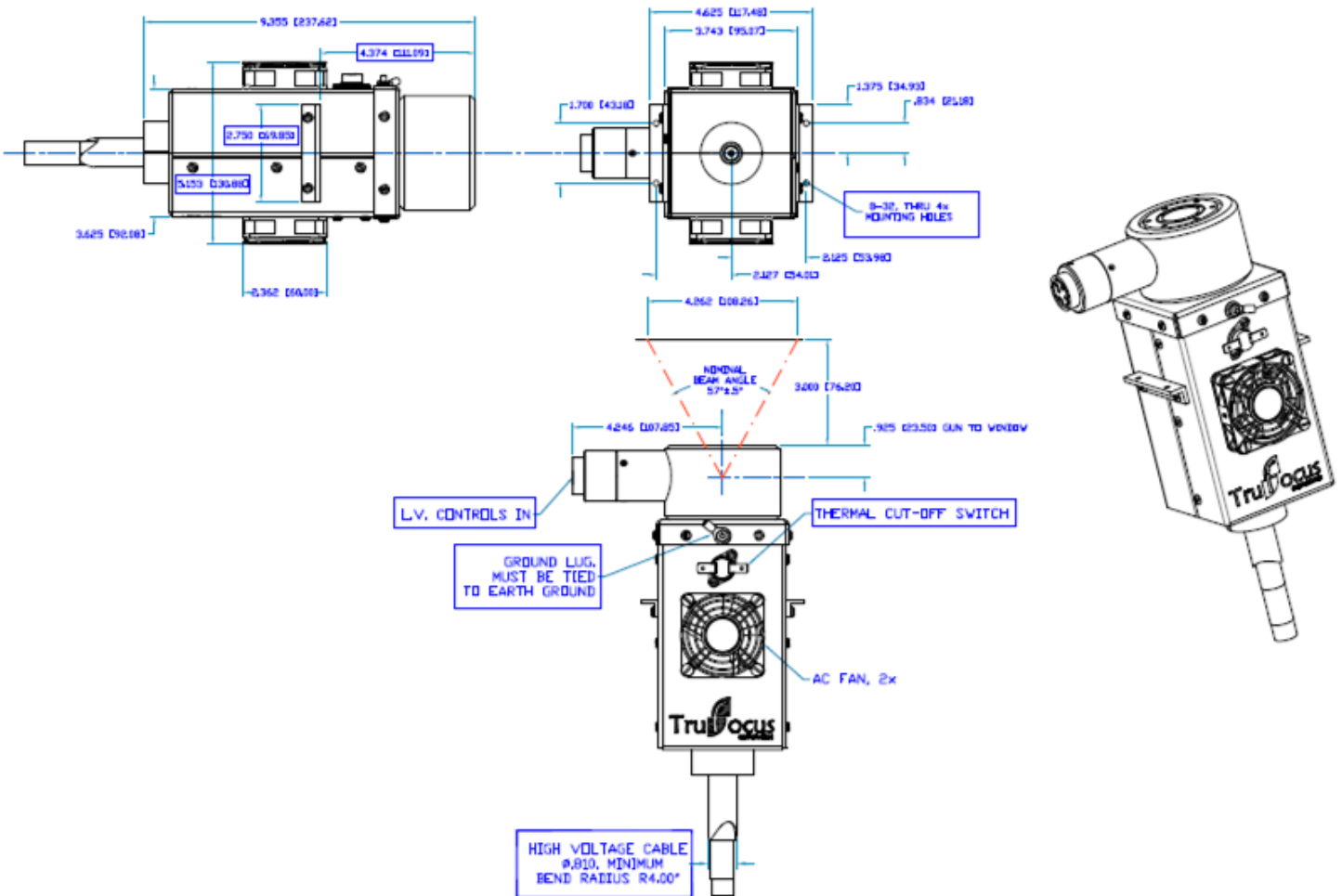

MicroFocus Digital Controller

MFX-CTR-100-1-D

Family	TruFocus Ordered P/N	Description	Max. Voltage (kV)	Max. Current (mA)	Max. Power (W)	Cooling Method	Weight	Programmable Control Interface
MFX	MFX-CTR-100-1-D	MicroFocus Digital Controller. For Controlling 8000 Series X-Ray Source family	100	1	100	Air	4.5 lb	Yes USB



Front View



Rear View

MicroFocus Digital Controller is specifically designed for controlling TruFocus 8000 Series X-Ray Tube Family. MicroFocus Digital Controller is to be used with TruFocus' High Voltage (HV) Module to form a fully programmable X-ray High Voltage Power Supply and Control sub-system. Achieving highest external EMI & HV surge immunity with Fiber to USB PC interface design. MicroFocus Digital Controller provides X-ray system designers many diagnostic and monitoring functions.

Functional Overview

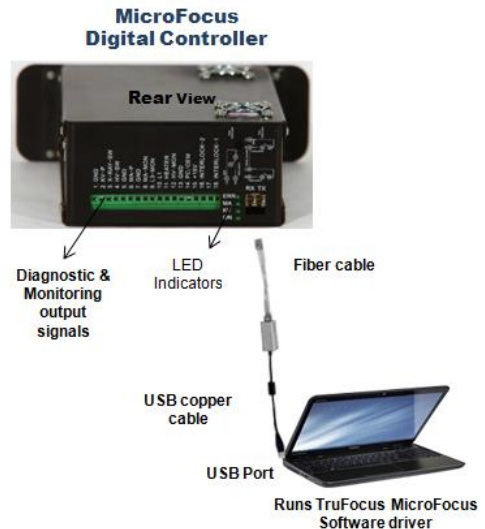
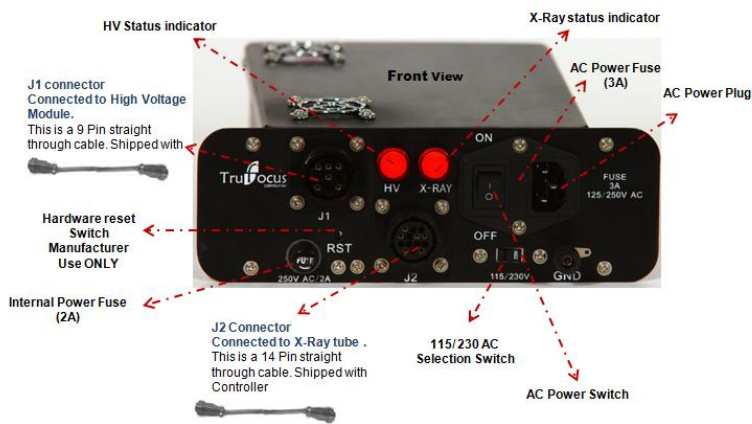

- Software Driver supports Window Vista, Window XP and Window 7
- Software Driver shipped with MicroFocus Digital Controller

MicroFocus Controller Sub-system connection

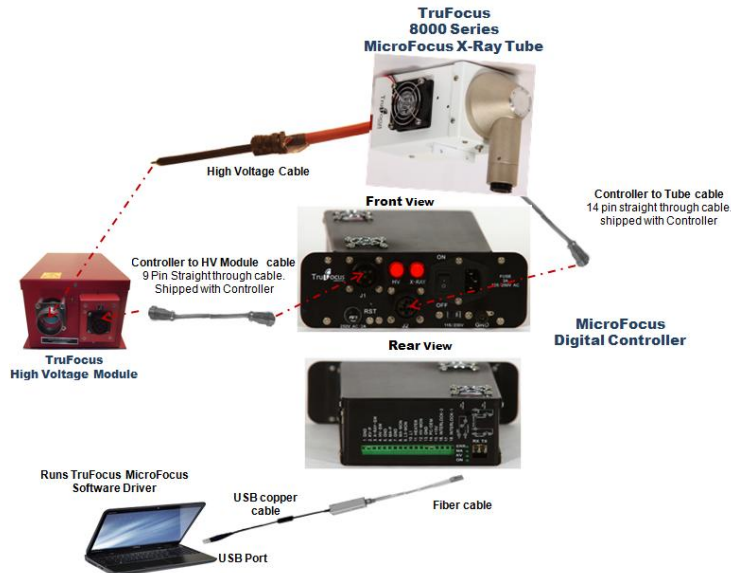

Diagnostic and Monitoring Function (Rear Panel Connector-Bar)

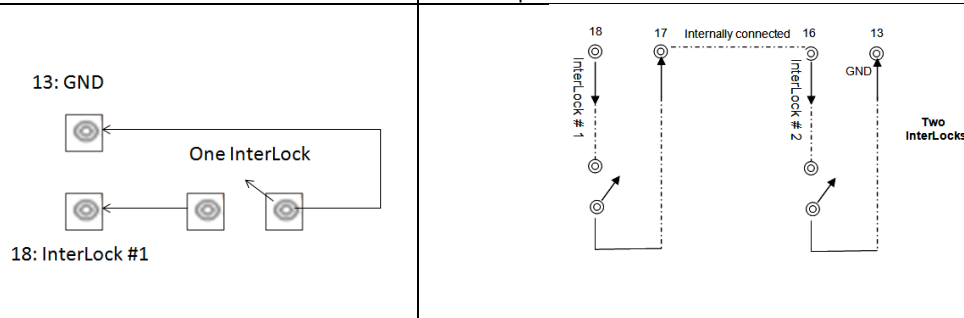
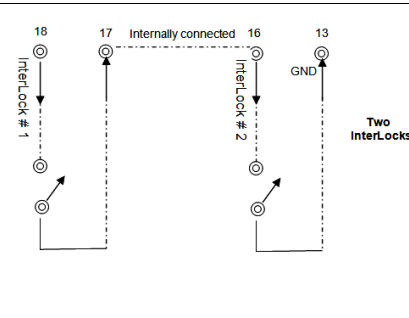
	I/O	Pin Function	Note
1		GND	GND
2	I	KV-P	KV Program, 10V= 100 kV
3	I	X-RAY-SW	X-Ray SW control
4	I	HV-SW	High Voltage control
5		GND	GND
6	I	MA-P	mA Program, 10V = 1 mA
7		GND	GND
8	O	MA-MON	mA Monitor
9	O	L3-MON	L3 Monitor
10	O	L1	L1 Monitor
11	O	HEATER	Heater Monitor
12	O	HV-MON	High Voltage Monitor
13		GND	GND
14	I	PC/OEM	PC/ Manual Mode selection (Input)
15	O	+15	+15V output
16 + 18			
17		Internal	Pin 16, 17, 18 used for InterLock control

OUTLINE DRAWING

Drawing# & Version:	DW- MFX-CTR-100-1-D-V01
TruFocus P/N:	MFX-CTR-100-1-D-V01
Unit:	Inch

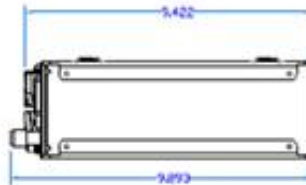
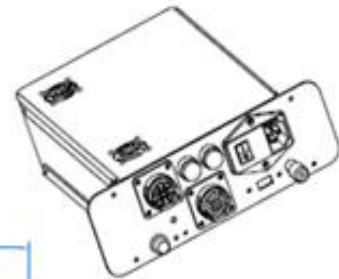
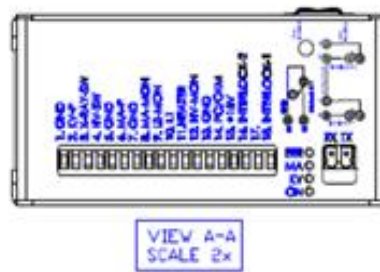
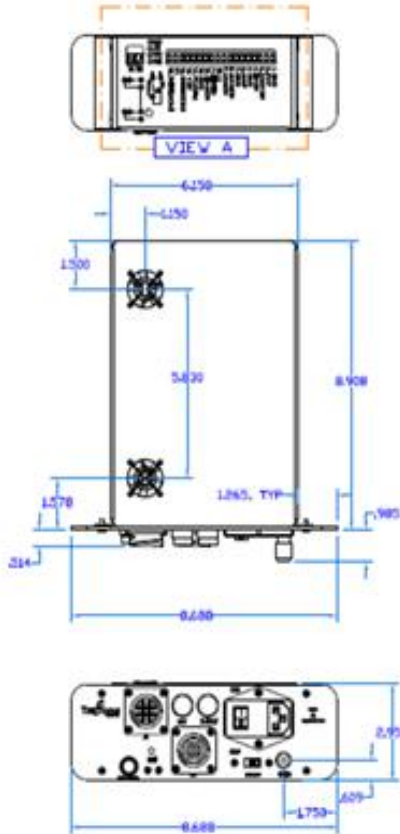

MFX-HVM-100-1

MicroFocus High Voltage (HV) Module

Family	TruFocus Ordered P/N	Description	Max. Voltage (kV)	Max. Current (mA)	Max. Power (W)
MFX	MFX-HVM-100-1	MicroFocus High Voltage Module supplies target voltage	100	1	100

HV output connector
to be connected to
X-Ray tube



Input Connector
to be connected to
MFX Controller

Front View

MicroFocus HV Module is a HV voltage multiplier (High Voltage Divider) and is designed in conjunction with TruFocus' MicroFocus Controller and MicroFocus X-Ray source to form a fully programmable MicroFocus X-Ray sub-system. MicroFocus Controller controls and monitors the output voltage and current of the MicroFocus HV Module.

High Voltage output connector

Parrameters	Specification	Note
Output kV	0 to 100 kV	100 kV max
Output Current (mA)	0 to 1 mA	1 mA max
kV Regulation	0.01%	
mA Regulation	0.01%	With feedback control
Output Stability	0.01%/ hr and 0.03%/ 8 hrs	
Ripple	0.1 % maximum	RMS
Temperature Coefficient	100 ppm / °C	

Connected to MicroFocus Analog Controller

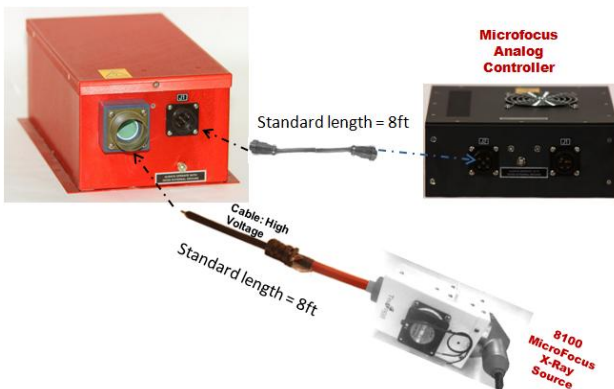

Connected to MicroFocus Digital Controller

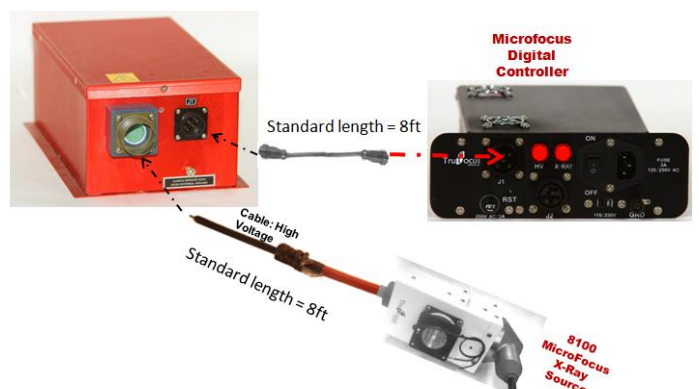

OUTLINE DRAWING

Drawing# & Version	DW- MFX-PS-100-1
TruFocus P/N	MFX-PS-100-1
Unit	In

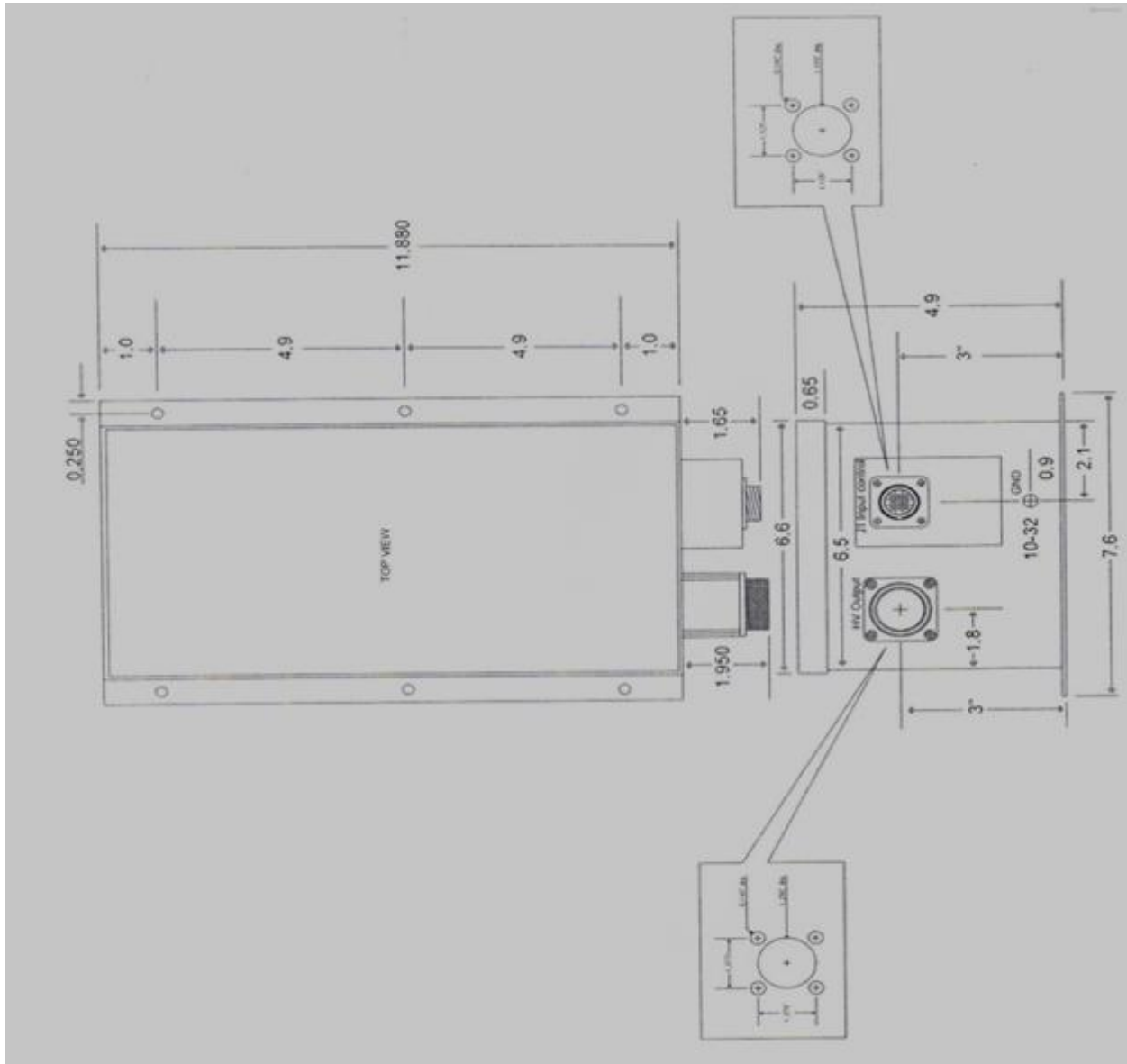

Caution

X-Ray Radiation



- 1. X-Ray radiation is harmful to the human body. It is necessary to take all safety precautions when operating this device.**
- 2. The x-ray tube should be installed in an x-ray shielded cabinet to avoid exposure. It is recommended that the safety interlock system be used at all times.**
- 3. It is the customer's responsibility to provide shielding for the use of this device.**

Warranty Information

This x-ray tube is warranted to be free of defects in materials and workmanship for a period of 365 days (1 year). This warranty is limited to repair or replacement of defective products only. This warranty replacement cost to customer shall be prorated over the duration of the warranty period. The warranty period commences on the date of installation, but no later than 30 days from the date of shipment from TruFocus to the customer. Any loss, damage, failure and/or malfunction relating in any way to accident, abuse, alteration, misuse, neglect, fitting, disassembly, attempted repair, storage, adjustments of the electronics, or failure to use the tube within the specifications or operating instructions provided by TruFocus, or the lack of proper routine maintenance and care of the tube or system in which it is installed are expressly denied coverage under this warranty.

Subject to local and technical requirements and regulations. Availability of product in this promotional material may vary. Please consult with our office staff for availability.

Information furnished by TruFocus is believed to be reliable. However, no responsibility is assumed for possible inaccuracies or omissions. Specifications are subject to change without notice. Patent rights are granted to any and all of the circuits described herein. © 2013 TruFocus Corporation